

HOSPIRA TM
ACCLAIM *encore*
Infusion Pump

System
Operating
Manual

For use with list 12237-04



Hospira, Inc.
Lake Forest, IL 60045, USA

CHANGE HISTORY

Part Number	Description of Change	Revised Pages
430-96202-001 (Rev. 09/98)	Original release	New
430-96202-002 (Rev. 10/98)	Second release	All
430-96202-003 (Rev. 5/99)	Third release	All
430-96202-A03 (Rev. 6/99)	Updated Cover	Front, back
	Updated Change History	i
	Updated Troubleshooting	36
	Updated Part Number only	17, 55
430-96202-004 (Rev. 9/99)	Fourth release	All
430-96202-A04 (Rev. 9/99)	Updated Cover	Front, back
	Updated Change History	i
	Updated Titrations Instructions	26
	Updated Part Number only	27, 55
430-96202-B04 (Rev. 6/00)	Updated Cover	Front, back
	Updated Change History	i
	Updated Copyright	iii
	Clarified Text	20, 21, 24, 25, 27
	Updated Part Number only	26, 28, 29, 32, 33, 53, 55
430-96202-C04 (Rev. 4/01)	Updated Cover	Front, back
	Updated Change History	i
	Updated Contents	ii
	Updated Copyright	iii
	Clarified Text	10, 18, 19, 36
	Updated Graphics	7, 13, 15, 16, 24, 25, 26
	Removed Sections	17
	Updated Part Number only	27, 28, 29, 34, 35, 37, 38, 40, 43, 46, 53, 54, 55
430-96202-D04 (Rev. 08/04)	Changed Abbott to Hospira Verbräge	Front and Back Covers, Change History, ii, iii, 4 thru 6, 9, 10, 12, 14, 18, 35, 39, 41, 43, 44, 47 thru 49 and 53 thru 55

Note: Change page manuals assembled by Hospira, Inc. include a change page identifier in the part number on the cover page and on the bottom of each changed page. This change page manual is identified as 430-96202-D04.

CONTENTS

1.0	INTRODUCTION	1
1.1	User Qualification	2
1.2	Conventions	3
1.3	Warnings, Cautions, and Notes	3
2.0	GETTING STARTED	5
2.1	Unpacking	5
2.2	Self-Test	5
3.0	COMPONENTS	7
3.1	Operating Keys	8
3.2	Additional Features	10
4.0	INSTRUCTIONS FOR USE	11
4.1	Setup	11
4.2	Container and Set Preparation	12
4.2.1	Container Preparation	12
4.2.2	Priming the Primary Set	13
4.2.3	Preparing for Secondary Delivery	14
4.3	Loading the Tubing	15
5.0	PROGRAMMING	19
5.1	Primary Only Delivery	20
5.2	Secondary Delivery (Piggyback Mode)	21
5.3	Volume/Time Delivery	23
5.4	Dose Calculation for MICROGRAM Delivery	24
5.5	To Titrate in Microgram Dosing	26
5.6	TPN Mode Delivery	27
5.7	KVO Operation	28
5.8	Changing Containers	29
5.9	Purge Feature	29
5.10	Clearing Total Volume	29
5.11	Optional User Settings	30
5.12	Lockout	33
5.13	Removal of Tubing	33
6.0	TROUBLESHOOTING	35
6.1	Alarms	35

6.2	Alerts	38
6.3	Malfunctions	38
6.4	Technical Assistance.	39
7.0	PRECAUTIONS	41
7.1	Artifacts	41
7.2	Healthcare Professional and Patient Related	41
7.3	Epidural Administration	43
7.4	Battery Operation	44
7.5	Sets and Accessories	44
7.6	General	45
8.0	CLEANING, MAINTENANCE, AND STORAGE	47
8.1	Cleaning and Sanitizing	47
8.2	Battery Maintenance	48
8.3	Storage	49
8.4	Service	49
9.0	SPECIFICATIONS	51
10.0	WARRANTY	53

1.0 INTRODUCTION

This manual contains instructions for using the Acclaim™ *encore* Infusion Pump. For the purpose of making this manual easier to read, the Acclaim *encore* Infusion Pump will be simply referred to as the Acclaim *encore*, pump or device, throughout the remainder of this manual.

The Acclaim *encore* is an infusion system designed to meet the growing demand for hospital, alternate site, and home healthcare standardization. The Acclaim *encore* is designed to deliver parenteral infusions including whole blood or red blood cell components and enteral fluids using a wide variety of standard administration sets and fluid containers. These features make the Acclaim *encore* a convenient and cost-effective infusion system.

The pump may be mounted on an IV stand.

The following features are included in the Acclaim *encore*:

- Easy to use interface
- Large LCD screen
- Numeric keypad entry
- Micro/Macro fluid delivery from 1.0 - 99.9 mL/hr in 0.1 mL/hr increments and 100 - 999 mL/hr in 1 mL increments
- Panel back illumination on AC power
- Battery backup
- Wide range of standard administration sets and accessories including LifeShield™ needleless sets
- Primary/Secondary delivery including automatic piggyback
- Dose Calc for weight-based (mcg/kg/min) delivery rate settings
- TPN mode for easy taper calculation
- Purge feature for easy removal of air
- Three occlusion pressure settings
- Air-in-line sensitivity- three optional settings

© Copyright 2004 Hospira, Inc. All Rights Reserved

This document and the subject matter disclosed herein are proprietary information. Hospira retains all the exclusive rights of dissemination, reproduction, manufacture and sale. Any party using this document accepts it in confidence, and agrees not to duplicate it in whole or in part nor disclose it to others without the written consent of Hospira.

- Keep Vein Open (KVO)
- Panel lockout switch
- Anti free-flow protection using slide clamp and tubing latch
- Automatic self-test
- Infinite memory retention
- Audible alarm volume selection
- Alarm history
- Epidural delivery
- Volume/Time programming for automatic primary or secondary flow rate calculation
- Optional secondary alert

1.1 User Qualification

The Acclaim *encore* is intended for use at the direction or under the supervision of licensed physicians or certified healthcare professionals who are trained in the use of the pump and the administration of parenteral and enteral fluids and drugs and whole blood or red blood cell components. This training should emphasize preventing related IV complications, including appropriate precautions to prevent accidental infusion of air. The epidural route can be used to provide anesthesia or analgesia.

WARNING

THIS PUMP CAN ADMINISTER ONLY THOSE ANESTHETICS/ANALGESICS APPROVED FOR EPIDURAL ADMINISTRATION (AS INDICATED OR ALLOWED BY THE DRUGS' FDA APPROVED LABELING). EPIDURAL ADMINISTRATION OF DRUGS OTHER THAN THOSE INDICATED FOR EPIDURAL USE COULD RESULT IN SERIOUS INJURY TO THE PATIENT.

1.2 Conventions

This section describes the conventions used throughout this manual:

Convention	Application	Example
<i>Italic</i>	Reference to a section, figure, or table Function or mode specific instructions	(See <i>Figure 3-1, Priming Cassette</i>) <i>Primary Only</i> : Attach an empty container...
[ALL CAPS]	Keys or touchswitches on the pump are described all caps in brackets	[SILENCE]
ALL CAPS Initial Caps lowercase	Screen displays and pump labels (as appropriate)	BATTERY
Bold	Emphasis	...sets are supplied Sterile and are for....

1.3 Warnings, Cautions, and Notes

Alert messages used throughout this manual are described below. Pay particular attention to these messages.

Specific Precautions can be found in Section 7 of this manual.

WARNING

A WARNING MESSAGE CONTAINS SPECIAL SAFETY EMPHASIS AND MUST BE OBSERVED AT ALL TIMES. FAILURE TO OBSERVE A WARNING MESSAGE IS POTENTIALLY LIFE THREATENING.

CAUTION: A CAUTION usually appears in front of a procedure or statement. It contains information that could prevent irreversible product damage or hardware failure. Neglecting to pay attention to a CAUTION could result in serious patient or user injury.

Note: A Note highlights information that helps explain a concept or procedure.



This symbol directs the user to consult accompanying documents.

Note: Figures are rendered as graphic representations to approximate the actual product; therefore, figures may not exactly reflect the product.

2.0 GETTING STARTED

This section describes the initial checkout procedures for the Acclaim *encore* Infusion Pump.

2.1 Unpacking

CAUTION: Product damage may occur unless proper care is exercised during unpacking and checkout. Do not use the pump if it appears damaged in any way. The battery may not be charged upon receipt.

Inspect the pump packaging for visible shipping damage. If any damage is found, contact the delivering carrier immediately.

Carefully remove the pump from the shipping carton. Retain the packing slip and save all packing material in case the pump is damaged or fails the self-test and has to be returned to Hospira.

Inspect the pump thoroughly for damage.

CAUTION: If the pump appears to be damaged; contact Hospira (see Section 6.4, *Technical Assistance*).

2.2 Self-Test

CAUTION: Do not place the pump in service if it fails the self-test.

Connect the AC power cord to AC power, then confirm that the AC power indicator illuminates (below the ON/OFF key). Place a primed administration set into the tubing door (see Section 4.0, *INSTRUCTIONS FOR USE*). Close the door. Turn the pump on by pressing [ON/OFF].

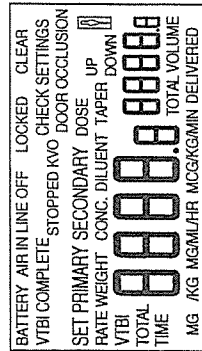

The LCD screen displays all the symbols briefly. Verify that the screen display exactly matches the illustration shown at the left. If the LCD screen does not match the illustration, remove the Acclaim *encore* from service and contact the hospital repair facility or Hospira Technical Support Operations.

After the Acclaim *encore* completes self-testing, disconnect it from AC power and confirm that BATTERY displays on the screen (indicating battery power is in use). To ensure the battery is fully charged, remove the administration set, then reconnect the Acclaim *encore* to AC power for a minimum of eight hours in OFF (CHARGE) mode.

Note: If an alarm occurs during the self-test, note the message, then take the appropriate corrective action (see *Section 6.0, TROUBLESHOOTING*). Repeat the self-test. If the alarm recurs, remove the Acclaim *encore* from service and contact Hospira Technical Support Operations.

Note: The Acclaim *encore* provides an optional Dose Calc function. This function is not enabled (off) when shipped from the factory. When not enabled, the [Dose Calc] key does not respond to user input. To enable the Dose Calc function (per hospital protocol), contact your facilities Biomedical Department.

3.0 COMPONENTS

The front and back of the Acclaim *encore* Infusion Pump components are illustrated below.

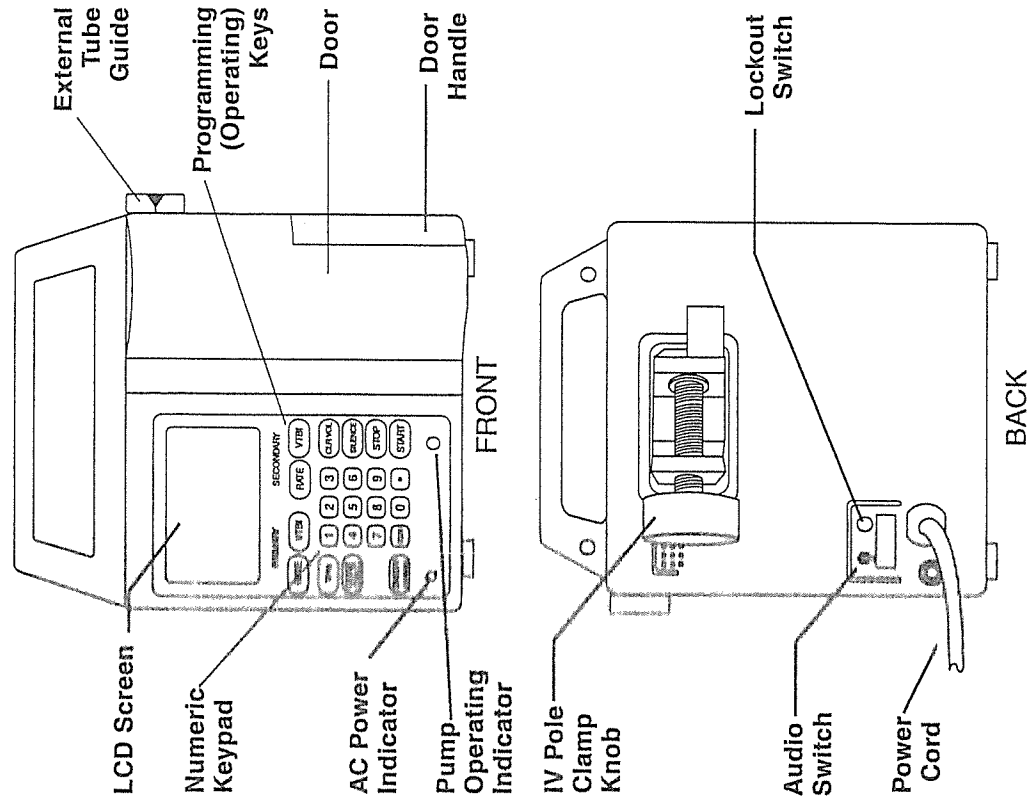

3.1 Operating Keys

PRIMARY DELIVERY:

RATE

Selects the primary fluid delivery rate. The delivery rate is programmed using the numeric keypad. The rate range is 1.0 to 99.9 mL/hr in 0.1 mL/hr increments and 100 to 999 mL/hr in 1 mL/hr increments.

VTBI

Selects the primary fluid volume to be infused/delivered (VTBI). The VTBI rate is programmed using the numeric keypad. The VTBI range is 1.0 to 99.9 mL in 0.1 mL increments and 100 to 9999 mL in 1 mL increments.

SECONDARY DELIVERY:

RATE

Selects the secondary fluid delivery rate. The delivery rate is programmed using the numeric keypad. The rate range is 1.0 to 99.9 mL/hr in 0.1 mL/hr increments and 100 to 999 mL/hr in 1 mL/hr increments.

VTBI

Selects the secondary fluid volume to be infused/delivered (VTBI). The VTBI range is programmed using the numeric keypad. The VTBI range is 1.0 to 99.9 mL in 0.1 mL increments and 100 to 9999 mL in 1 mL increments.

TPN:

TPN

Delivers a set volume of fluid over a selected time (hours) including the ability to input taper up duration and taper down duration in minutes.

**DOSE
CALC**

Delivers in mcg/kg/min dosing.

Note: This function is not enabled when shipped from the factory. To enable the Dose Calc function, contact your facilities Biomedical Department.

GENERAL KEYS:

1

2

3

4

5

6

7

8

9

0

.

[**NUMERIC KEYPAD**] is used to program and change delivery rates and volumes.

CLR

Clears the programmed number (resets to zero). Also used to clear all previous settings at start up.

Note: If the purge feature has been enabled, the user can purge a segment of air past the distal air sensor (in the event of an air-in-line alarm) by pressing the [CLR] key. (see Section 5.9, *Purge Feature*)

CLR VOL

Clears the total volume delivered (if pressed twice within 15 seconds).

SILENCE

Temporarily mutes audible alarms and stops the LCD screen backlight from flashing. The alarm display continues to flash. The audible alarm resumes after two minutes if the alarm condition is not corrected. To silence a low battery alarm, refer to the alarm tips in Section 6.1, *Alarms*.



Stops fluid delivery. Fluid containers can be changed in this setting. If the pump is in an alarm condition, [STOP] also silences the audible alarm.

Note: If the pump is in STOP mode for five minutes, and no other key is pressed, the alarm sounds.



Starts fluid delivery at the rate set by the user. Confirms titrated (changed while infusing) individual, primary or secondary entries or any of microgram delivery entries.



Turns the pump on and off. If fluid delivery is in progress, the [STOP] key must be pressed before turning the pump off.

Note: The battery charges as long as the Acclaim *encore* remains connected to AC power.

3.2 Additional Features



AUDIO SWITCH (located on the rear panel) is a toggle switch which has three sound-level settings.



LOCKOUT SWITCH (located on the rear panel) is a pushbutton (Push On, Push Off) switch that may be used to avoid unauthorized changes to the Acclaim *encore* settings.

4.0 INSTRUCTIONS FOR USE

This section describes the Acclaim *encore* Infusion Pump setup, including the use of appropriate administration sets.

4.1 Setup

WARNING

ARRANGE TUBING, CORDS, AND CABLES TO MINIMIZE THE RISK OF PATIENT STRANGULATION OR ENTANGLEMENT.

To set up the Acclaim *encore*, plug the power cord into an AC power outlet, unless temporary battery operation is desired.

Note: Use AC power whenever possible. To ensure a fully charged battery for emergency use, store the Acclaim *encore* with the pump connected to AC power.

Set the audio switch to the desired volume level by turning the switch to the upper position for the HIGH setting, the middle position for the MEDIUM setting, or to the bottom position for the LOW setting.

The Acclaim *encore* may be safely and conveniently mounted on an IV stand.

4.2 Container and Set Preparation

WARNINGS

THE ACCLAIM *encore* CAN BE USED ONLY WITH HOSPIRA GRAVITY ADMINISTRATION SETS WITH GREEN SLIDE CLAMPS. THE USE OF ANY OTHER SET WILL RESULT IN A SLIDE CLAMP ALARM.

WHEN STARTING AN INFUSION, CONFIRM THAT THERE IS FLOW IN THE DRIP CHAMBER.

ALWAYS PLACE FILTERS DISTAL TO THE INFUSER TO MINIMIZE THE POSSIBILITY OF UNDERDELIVERY OR AN AIR-IN-LINE ALARM DUE TO OUTGASSING.

Note: To determine the appropriate Hospira administration set to use, see *Section 7.5, Sets and Accessories*.

Prepare the fluid container and administration set using aseptic technique. Remove protective coverings as the assembly progresses.

4.2.1 CONTAINER PREPARATION

To prepare an IV container:

Close the roller clamp on the administration set.

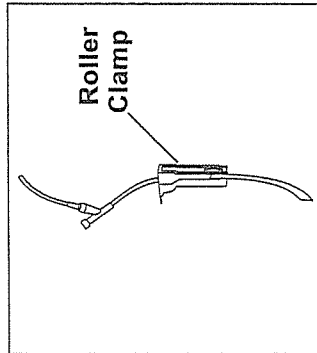

Expose the outlet of the IV container, then insert the piercing pin into the outlet with a twisting motion.

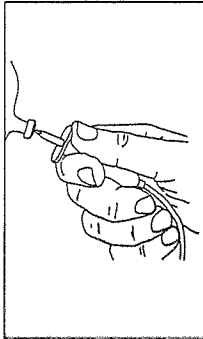

Suspend the container from the IV stand and fill the drip chamber to the score mark. Do not overfill the drip chamber.

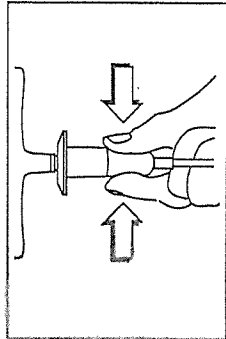

Note: When changing containers, stop the infusion to avoid nuisance air in line alarms, then set up a new VTBI if necessary.

4.2.2 PRIMING THE PRIMARY SET

Note: The set must be manually primed before loading into the pump.

To prime the primary set:

Suspend the primary container administration set drip chamber about 18 inches above the pump.

Prepare and prime the set per the package instructions, taking special care to purge all air bubbles.

Note: Dislodge air from each backcheck valve and Y-site by inverting and tapping it sharply while the fluid is flowing. This helps avoid air in line alarms during operation.

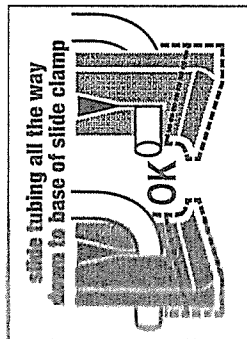

Close the roller clamp.

Close the upper green slide clamp completely for free flow protection.

Note: For sets with backcheck valves, position slide clamp at least 4 inches below the upper backcheck valve.

Complete the procedure by loading the primed administration set into the pump (see Section 4.3, *Loading the Tubing*).

4.2.3 PREPARING FOR SECONDARY DELIVERY

WARNING

WHEN USING THE PUMP FOR SECONDARY DELIVERY, CONFIRM THAT THE FLUIDS BEING ADMINISTERED ARE CHEMICALLY AND PHYSICALLY COMPATIBLE.

To prepare for secondary delivery:

Confirm that a **primary piggyback administration set** is in place (set has an upper backcheck valve).

Suspend the **primary container** from the IV stand using the **extension hook** provided with the secondary set.

Prepare the **secondary set** per the package instructions. **Attach a needle or blunt cannula (if appropriate)** and prime the secondary set. **Close the tubing clamp** and suspend the **secondary container** from the IV stand.

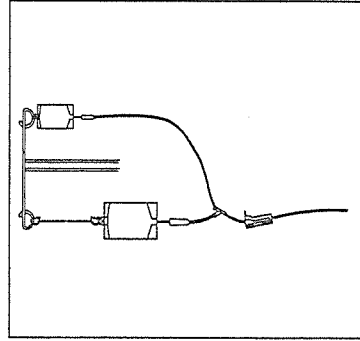
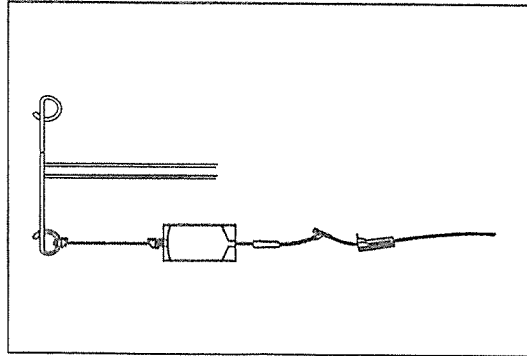

Connect the secondary set to the upper backcheck Y-injection site (or upper luer port) using aseptic technique (refer to the secondary set package instructions).

Note: When using large secondary containers (500mL or above), confirm that the bottom of the secondary container is at least 7 inches above the fluid level in the primary container. Use additional extension hooks if necessary.

Note: At higher secondary rates (i.e. about 300 mL/hr or higher), flow may occur from the both primary and secondary containers. Under these conditions, apply an external clamp (such as a hemostat) to the primary line to prevent flow from the primary container. Closely monitor operation at end of secondary delivery and remove clamp just before secondary container empties, to avoid AIR-IN-LINE alarm.

4.3 Loading the Tubing

To load the primed set into the Acclaim *encore*:

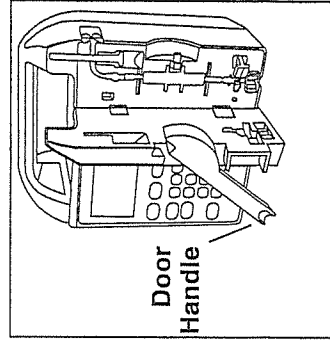

Open the pump door by lifting the door handle.

Note: Do not use sharp objects such as fingernails, paper clips, or pens to push the tubing into the mechanism.

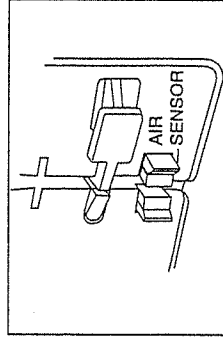

Note: When air is detected, it will normally be found near the air sensor at the distal end of the pump.

Note: If the administration set is removed from the pump, use a fresh segment of tubing when reloading the administration set back in the pump.

NOTE: Please review Section 4 for complete instructions for steps 1-5.

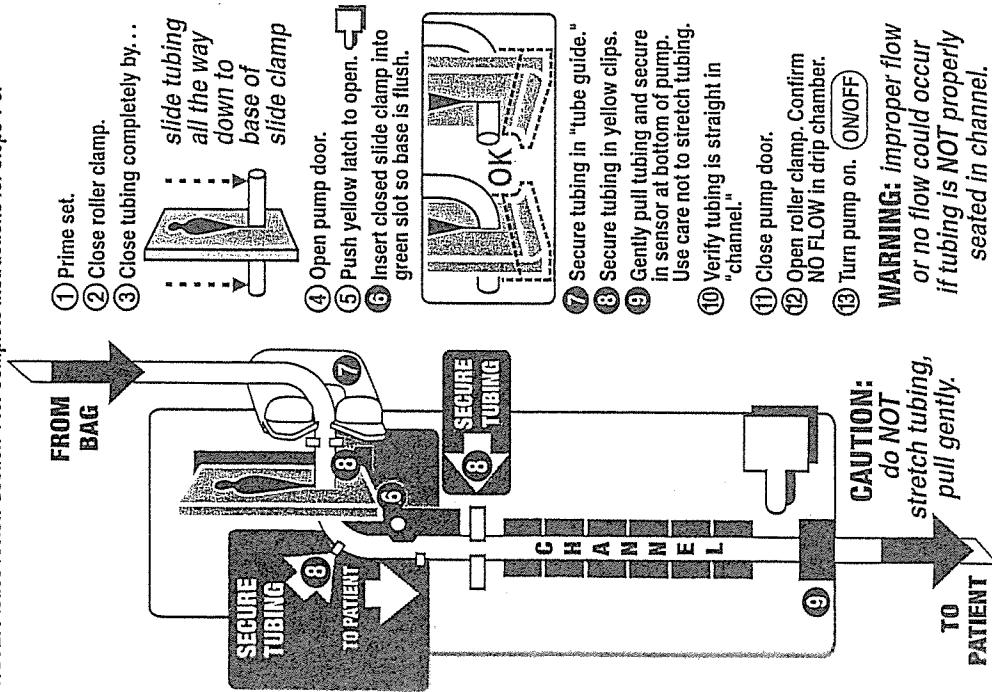

- 1 Prime set.
- 2 Close roller clamp.
- 3 Close tubing completely by...

slide tubing all the way down to base of slide clamp
- 4 Open pump door.
- 5 Push yellow latch to open.
- 6 Insert closed slide clamp into green slot so base is flush.
- 7 Secure tubing in "tube guide."
- 8 Secure tubing in yellow clips.
- 9 Gently pull tubing and secure in sensor at bottom of pump. Use care not to stretch tubing.
- 10 Verify tubing is straight in "channel."
- 11 Close pump door.
- 12 Open roller clamp. Confirm NO FLOW in drip chamber.
- 13 Turn pump on. (ON/OFF)

WARNING: improper flow or no flow could occur if tubing is NOT properly seated in channel.

WARNING

IMPROPER FLOW OR NO FLOW COULD OCCUR IF TUBING IS NOT PROPERLY SEATED IN CHANNEL. MAKE SURE TUBING IS STRAIGHT, BUT NOT STRETCHED DURING THE LOADING PROCESS. STRETCHED TUBING COULD RESULT IN UNDERDELIVERY OF FLUIDS.

5.0 PROGRAMMING

The Acclaim *encore* has these delivery modes:

- Primary only delivery
- Secondary delivery (Piggyback Mode)
- Volume/Time delivery
- TPN mode delivery
- DOSE CALC delivery (Weight Based Mode) (optional)

When a rate and a VTBI are entered for the primary and no or incomplete settings are entered for the secondary, the Acclaim *encore* will deliver primary only.

When a rate and a VTBI are entered for both primary and secondary fluids (secondary delivery), the Acclaim *encore* completes secondary delivery before it begins primary delivery.

TPN mode delivery is used to deliver a set volume of fluid over a selected time duration in hours. TPN mode features an optional increasing of the delivery rate at the beginning of the programmed delivery (taper up) and an optional decreasing of the delivery rate at the end of the programmed delivery (taper down). The delivery rate in between remains constant.

NOTES

- The device retains all previous therapy settings and fluid delivery data in its memory until the settings are cleared by the user. Check the primary and secondary settings during the initial setup to confirm that all settings are correct. Confirm the proper clearing of the total volume delivered before use.
- Secondary (Piggyback) delivery is available ONLY when a primary delivery has been programmed. Secondary delivery is NOT available in TPN or DOSE CALC modes.
- To activate TPN, press the [TPN] key while pump is stopped.
- To activate Dose Calculation, you must press the [DOSE CALC] key.
- Once [START] has been pressed, the pump operating indicator on the front of the pump is illuminated. This is NOT an indication that fluid is flowing. Check the drip chamber to confirm flow.
- While delivery is in progress and a setup key is pressed, the parameter corresponding to the pressed key will be displayed for 15 seconds. If the [START] key is not pressed to confirm the change entered, the pump will revert back to the previous settings at which the pump was delivering fluid. The screen will continue to flash indicating a change had been attempted. Press [START] to stop flashing.
- Decimals cannot be entered for most values of 100 and greater, nor during entry of TPN mode parameters. In these instances, pressing the decimal key after entering three digits will enter the displayed whole number value. No further number keys will be accepted. Press [CLR] to enter a different number.
- The Acclaim *encore* provides an optional Dose Calc function. This function is not enabled (off) when shipped from the factory. When not enabled, the [Dose Calc] key does not respond to user input. To enable the Dose Calc function (per hospital protocol), contact your facilities Biomedical Department.

This page intentionally left blank.

5.1 Primary Only Delivery

During programming, the selected units of measure *flash*.
To program the Acclaim *encore* for primary only delivery:

SET PRIMARY RATE	CLEAR SETTINGS	125	225	TOTAL VOLUME DELIVERED
		ML/HR		

If pump is not already on, press [ON/OFF].

Note: After the self-test, the LCD shows the previously programmed settings and "CLEAR SETTINGS" flashes on the upper part of the screen. The screen will display the settings that were in memory before the device was stopped (primary, secondary, dose calc, or TPN infusions).

For new patient setup, press [CLR] to erase all previous settings, including the total volume delivered. Pressing any other key will retain previous settings.

SET PRIMARY RATE	0	0	TOTAL VOLUME DELIVERED
	ML/HR		

SET PRIMARY RATE	125	0	TOTAL VOLUME DELIVERED
	ML/HR		

Press the PRIMARY [RATE] key and enter the primary delivery rate using the numeric keypad (mL/hr).

SET PRIMARY VTBI	1000	0	TOTAL VOLUME DELIVERED
	ML		

Press the PRIMARY [VTBI] key and enter the primary volume to be infused (mL). The pump will give a 5 tone alert every minute if the [START] key is not pressed. This reminds the user that the [START] key has not been pressed.

PRIMARY RATE	125	0	TOTAL VOLUME DELIVERED
	ML/HR		

Press [START] to begin primary only delivery. Make sure primary is infusing by observing drops falling in drip chamber of primary infusion.

PRIMARY RATE	125	150	TOTAL VOLUME DELIVERED
	ML/HR		

(Optional): Set the panel lockout switch to LOCKED to avoid unauthorized tampering with the pump (see Section 5.12, *Lockout*).

To Titrate or change a primary delivery rate while infusing:

Press the PRIMARY [RATE] key, enter a new rate (mL/hr). Rate will flash to indicate it was changed. Press [START] (within 15 seconds) to begin infusing at the new rate. **Verify flow in drip chamber.**

Note: If the [START] key is not pressed (within 15 seconds) as confirmation of the new rate, the setting will return to the old rate and continue to flash. To stop flashing, press [START].

Note: If another delivery setting key was pressed prior to [START], the previous change entry is discarded as not confirmed.

Note: If you change your mind after entering a new delivery parameter, press [CLR] twice.

5.2 Secondary Delivery (Piggyback Mode)

During programming, the selected units of measure *flash*.

Note: Secondary delivery is not available without primary being programmed. It is also not available when in Dose Calc or TPN mode.

Note: Lower the primary container with the extension hook provided in the secondary set.

To program the Acclaim *encore* for secondary delivery:

SET PRIMARY RATE	125	0	TOTAL VOLUME DELIVERED
	ML/HR		

If not already programmed, press the PRIMARY [RATE] key and enter the primary delivery rate using the numeric keypad (mL/hr).

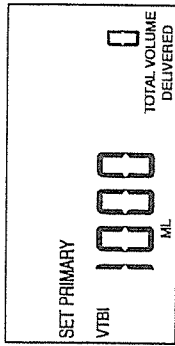

Press the PRIMARY [VTBI] key and enter the primary volume to be infused (mL).

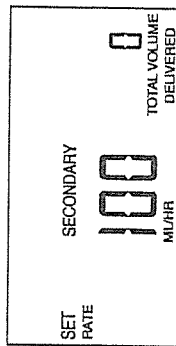

Press the SECONDARY [RATE] key and enter the secondary delivery rate (mL/hr).

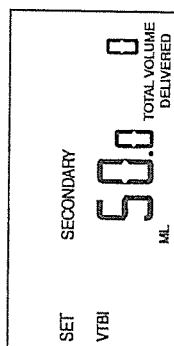

Press the SECONDARY [VTBI] key and enter the secondary volume to be infused (mL).

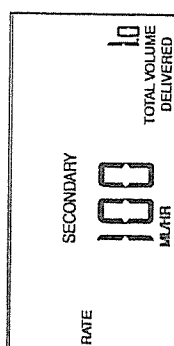

Press [START] to begin secondary delivery. Make sure secondary is infusing by observing drops falling in drip chamber of secondary infusion.

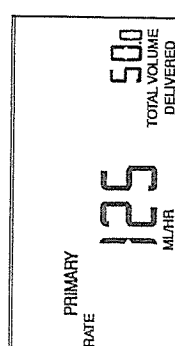

After completion of the secondary volume, the pump automatically switches to the primary rate. If the secondary alert option is enabled, the secondary alert will sound.

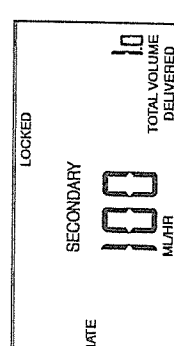

Note: If secondary VTBI understates actual total secondary volume, the potential exists for delivering residual secondary volume at the primary rate.

(Optional): Set the panel lockout switch to LOCKED to avoid unauthorized tampering with the pump settings (see Section 5.12, Lockout).

To Titrate or change a secondary delivery rate while infusing:

Press the SECONDARY [RATE] key, enter a new rate using the numeric keypad (mL/hr). Rate will flash to indicate it was changed. Press [START] (within 15 seconds) to begin infusing at the new rate. Verify flow in secondary drip chamber.

Note: If the [START] key is not pressed (within 15 seconds) as confirmation of the new rate, the setting will return to the old rate and continue to flash. To stop flashing, press [START].

Note: If another delivery setting key was pressed prior to [START], the previous change entry is discarded as not confirmed.

Note: If you change your mind after entering a new delivery parameter, press [CLR] twice.

To stop a secondary delivery in progress:

Press the secondary [RATE] or [VTBI] key.

Press [CLR] or enter "0".

Clamp secondary tubing or disconnect from primary set.

Press [START]. Verify flow in primary drip chamber.

The primary infusion begins at this point.

5.3 Volume/Time Delivery

The Acclaim Encore can automatically calculate the primary or secondary delivery rate. To program the Device for Volume/Time delivery:

Press [STOP] (if infusing).

Press the PRIMARY or SECONDARY [VTBI] key and enter the volume to be infused using the numeric keypad (mL).

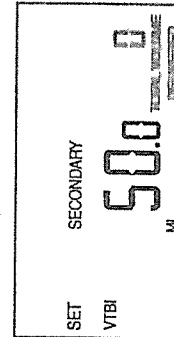

SET SECONDARY TIME 30 TOTAL VOLUME MIN DELIVERED 0

Press the same [VTBI] key again and enter the time duration of primary or secondary delivery (minutes). The range is 1-1440 minutes.

SET SECONDARY RATE 100 ML/HR TOTAL VOLUME DELIVERED 0

Press [START]. LCD shows the rate of infusion that the pump has calculated. Verify flow in drip chamber.

SET PRIMARY RATE --- ML/HR TOTAL VOLUME DELIVERED 00 CHECK SETTINGS

Note: If calculated rate is outside limits, a CHECK SETTINGS alarm will occur when [START] key is pressed. RATE will be displayed as four dashes. To correct, press [CLR] and enter values which produce valid rates.

Note: Volume/Time delivery is not available for MICROGRAM delivery.

Note: After a CHECK SETTINGS alarm or entry of new VTBI, TIME setting may change from existing value. [CLR] will set time to "0".

5.4 Dose Calculation for MICROGRAM Delivery (optional)

During programming, the selected units of measure flash.

Note: The Acclaim *encore* provides an optional Dose Calc function. This function is not enabled (off) when shipped from the factory. When not enabled, the [Dose Calc] key does not respond to user input. To enable the Dose Calc function (per hospital protocol), contact your facilities Biomedical Department.

Note: See section 9, *Specifications*, for range of valid entries.

Note: Secondary delivery is not available in this mode.

To program the Acclaim *encore* Infusion Pump for MICROGRAM Delivery:

SET WEIGHT 55.0 KG TOTAL VOLUME DELIVERED 0

Press [DOSE CALC] and enter the patient weight in kilograms.

Note: If you are not doing weight based dosing (you are doing mcg/min instead of mcg/kg/min) enter zero for the weight.

SET MG 200 TOTAL VOLUME DELIVERED 0

Press [DOSE CALC] and enter the drug amount (mg).

SET DILUENT 500 ML TOTAL VOLUME DELIVERED 0

Press [DOSE CALC] and enter the diluent (mL).

SET DOSE RATE 100 MCGS/KG/MIN TOTAL VOLUME DELIVERED 0

Press [DOSE CALC] and enter the dose rate (mcg/kg/min) or (mcg/min).

SET PRIMARY RATE 82.5 ML/HR TOTAL VOLUME DELIVERED 0

Press [DOSE CALC] to display the computed rate (mL/hr).

If the Volume to be Infused (VTBI) is the same as the diluent volume, then press [START] to begin infusion.

SET PRIMARY VTBI 80.0 ML TOTAL VOLUME DELIVERED 0

If a different volume is to be infused, then press PRIMARY [VTBI] and enter the VTBI (mL).

CHECK CONC 200 MCGS/KG/MIN VOLUME DELIVERED 500

Press [START]. The pump will ask you to confirm the drug concentration.

RATE	DOSE	TOTAL VOLUME DELIVERED
10.0	0.1	0.1
	MC/KG/HR	MC/KG/HR

If the concentration is correct, press [START] or press [DOSE CALC] to begin changing the concentration and diluent.

Note: To review Microgram Delivery settings, repeatedly press [DOSE CALC] prior to pressing [START] that begins the infusion.

Note: Secondary delivery cannot be programmed when pump is in Dose Calc mode.

SET RATE	CHECK SETTINGS	DOSE	TOTAL VOLUME DELIVERED
1050		0	0
		MC/KG/HR	MC/KG/HR

Note: If calculated rate (mL/hr) is outside limits, a CHECK SETTINGS alarm will occur.

5.5 To Titrate in MICROGRAM Dosing (optional)

Note: To perform this function, Dose Calc mode must be enabled.

To change dose:

SET RATE	DOSE	TOTAL VOLUME DELIVERED
70	153	0
	MC/KG/HR	MC/KG/HR

Press [DOSE CALC], enter the new dose rate and press [START].

Note: If the [START] key is not pressed (within 15 seconds) as confirmation of the new Dose rate, the setting will return to the old Dose rate and continue to flash. To stop flashing, press [START].

Note: If another delivery setting key was pressed prior to [START], the previous change entry is discarded as not confirmed.

Note: If you change your mind after entering a new delivery parameter, press [CLR] twice.

To Titrate VTBI (while infusing):

SET PRIMARY VTBI	DOSE	TOTAL VOLUME DELIVERED
22.9	325	0
	ML	ML

Press Primary [VTBI], enter the new VTBI (mL) and press [START].

Note: If the [START] key is not pressed (within 15 seconds) as confirmation of the new VTBI, the setting will be discarded and the display will continue to flash. To stop flashing, press [START].

Note: If another delivery setting key was pressed prior to [START], the previous change entry is discarded as not confirmed.

Note: If you change your mind after entering a new delivery parameter, press [CLR] twice.

CHECK DOSE	DOSE	TOTAL VOLUME DELIVERED
250	100	0
MG	MG	ML

The display flashes for confirmation of the drug concentration.

Press [START] (within 15 seconds) to confirm.

5.6 TPN Mode Delivery

During programming, the selected units of measure flash.

Note: See section 9, *Specifications*, for range of valid entries.

If pump is not already on, press [ON/OFF].

Note: After the self-test, the screen shows the previously programmed settings and "CLEAR SETTINGS" flashes on the upper part of the screen. The screen will display the settings that were in memory before the device was stopped (primary, secondary, dose calc, or TPN infusions).

For new patient setup, press [CLR] to erase all previous settings, including the total volume delivered. Pressing any other key will retain previous settings.

To Program the Acclaim Encore for TPN delivery:

SET VTBI	DOSE	TOTAL VOLUME DELIVERED
2000	0	0
ML	ML	ML

Press [TPN] and enter the total volume of fluid to be delivered using the numeric keypad (mL).

SET TOTAL TIME	DOSE	TOTAL VOLUME DELIVERED
12	0	0
HR	HR	ML

Press [TPN] again and enter the total time (hours) of the infusion.

If taper up or taper down mode is not required, press [START]. Verify flow in drip chamber.

SET TAPER UP	DOSE	TOTAL VOLUME DELIVERED
30	0	0
MIN	MIN	ML

If the taper up feature is desired, press [TPN] again and enter the taper up time (minutes).

If the taper down feature is desired, press [TPN] again and enter the taper down time (minutes)

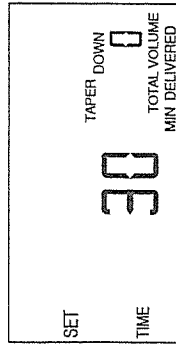

Press [START]. Verify flow in drip chamber.

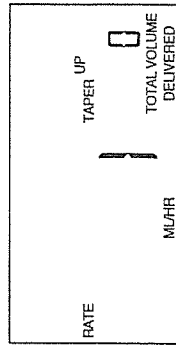

Note: Fluid delivery will occur at a computed steady state rate based on the VTBI and the time entered. If calculated rate is outside limits, a CHECK SETTINGS alarm will occur.

Note: If the taper up time is entered, the rate will start at 1 mL/hr and increase until it reaches the steady state rate.

Note: If the taper down time is entered, the taper down delivery will begin when the remaining volume to deliver equals the volume determined for taper down. The rate will be decreased until completion of the taper delivery volume is reached.

To taper down for an emergency, press [TPN] while the infusion is in progress. Continue pressing [TPN] until the taper down screen appears.

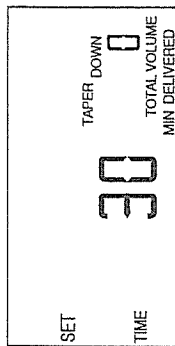

Enter an emergency taper down time and press [START]. Verify flow in drip chamber. The taper down function immediately begins.

Note: After an emergency taper down, the taper VTBI may not be zero. To restart taper, check settings and press [START].

5.7 KVO Operation

When the primary VTBI or taper VTBI is complete or when an emergency taper down is performed, the VTBI COMPLETE alarm sounds and the delivery operation changes to KVO delivery. During KVO operation, fluid is delivered at 1.0 mL/hr.

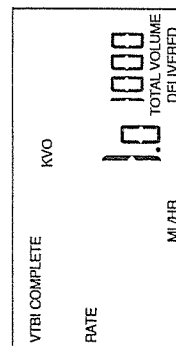

5.8 Changing Containers

To change a container, press [STOP]. Spike the new container using aseptic technique. Press PRIMARY or SECONDARY [VTBI]. Enter in the new VTBI. Press [START] to continue the infusion. Verify flow in drip chamber.

5.9 Purge Feature

The *Accclaim Encore* allows the user to purge a segment of air past the distal air sensor in the event of an air-in-line alarm. See *Section 5.11, Optional User Settings*, for information on enabling the purge feature. To purge the air, press and hold [CLR]. The amount of fluid that can be purged is dependent on the programmed delivery rate. No more than 1 mL can be purged at one time. Press [START] to continue the infusion. Verify flow in drip chamber. Remove air at the nearest Y site.

Purge Parameters and Limits

Rate	Maximum Volume per Alarm Occurrence	Purge Rate
1 - 5.9 mL/hr	0 mL	0 mL/hr
6 - 10.9 mL/hr	0.2 mL	50 mL/hr
11 - 60.9 mL/hr	0.5 mL	300 mL/hr
61 - 999 mL/hr	1 mL	999 mL/hr

Note: For any delivery rate less than 6 mL/hr, the purge feature will not function.

5.10 Clearing Total Volume

To clear the total volume that has been delivered:

Record total volume delivered in lower right corner of LCD screen.

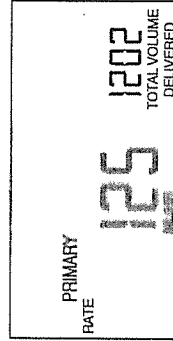

Press [CLR VOL]. While the total volume delivered is flashing, press [CLR VOL] again.

Note: If the [CLR VOL] key is not pressed within 15 seconds of the total volume value flashing on the screen, the total volume delivered remains unchanged

5.11 Optional User Settings

The Acclaim *encore* has three settings that can be changed by the user:

- Occlusion level
- Purge feature
- Secondary alert

The new selections will remain until the user *again* changes them with this same procedure. The following table *details* the optional user settings.

Note: In order to access these features, the pump must be *off*.

Setting	Default	Description	Action
Occlusion Level	L2	LOW: L1 (approximately 6 psi)	Press [ON/OFF].
		MEDIUM: L2 (approximately 10 psi)	During self-test press and hold PRIMARY [RATE] until self-test screen disappears.
		HIGH: L3 (approximately 20 psi)	Press PRIMARY [RATE] again to toggle between L1, L2, and L3.
Purge Feature	On	The ability to purge during an air-in-line alarm	Press [ON/OFF]. During self-test press and hold PRIMARY [VTBI] until self-test screen disappears. Press PRIMARY [VTBI] again to toggle on or off.

Setting	Default	Description	Action
Secondary Alert	Off	The pump beeps five times upon completion of secondary delivery and begins primary delivery	Press [ON/OFF]. During self-test press and hold SECONDARY [RATE] until self-test screen disappears. Press SECONDARY [RATE] again to toggle on or off.

To check all three settings:

Toggle from PRIMARY [RATE] to PRIMARY [VTBI] to SECONDARY [RATE] in order to check occlusion level, purge feature, and secondary alert, respectively. Press [ON/OFF] to turn pump off. Press [ON/OFF] again to begin operational programming.

Air-in-Line Sensitivity

The Acclaim *encore* features Air-in-line sensitivity settings that can be adjusted according to the intended use of pump. This feature is available through the General Service Mode and pump must be off.

Press [ON/OFF]. During the Self Test, press and hold the [0] key until the pump displays the software revision number.

Press SECONDARY [VTBI].

See Table on following page.

5.12 Lockout

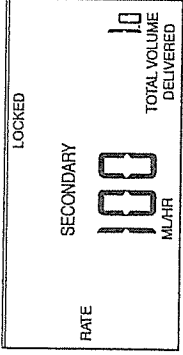

To avoid unauthorized tampering with device settings, use the panel LOCKOUT switch (*rear of pump*). Press the white switch to activate the lockout. When the lockout switch is on, LOCKED appears on the LCD screen and all keys except the [STOP] key are inactive. If the [STOP] key is pressed, the infusion will stop and the pump will alarm. To enable the keypad and silence the alarm, press the LOCKOUT switch.

Note: If the lockout switch has been enabled while the *Acclaim ETCO₂* is turned off, the screen will indicate LOCKED and no programming will be possible once the pump is turned on. In this case, the LOCKOUT switch must be unlocked.

5.13 Removal of Tubing

- 1) With pump stopped or off, close roller clamp.
- 2) Open the door handle.
- 3) Press the yellow tubing latch.
- 4) To remove the tubing from the tubing channel, begin at the bottom of the pump and proceed towards the green slide clamp slot.
- 5) Grasp the tubing on each side of the green slide clamp.
- 6) Pull the tubing straight out to remove the slide clamp (in its closed position) from the slide clamp slot.

WARNING

DO NOT PRESS THE GREEN SLIDE CLAMP SLOT TAB WHILE REMOVING THE TUBING AND SLIDE CLAMP. DOING SO COULD ALLOW FREE FLOW TO OCCUR.

Feature	Description	Action
Air-in-line alarm sensitivity setting	L1 : Air-in-line alarms at 100 μ L or greater of continuous air, or 200 μ L of air in any consecutive 2 mL of fluid L2 : Air-in-line alarms at 200 μ L or greater of continuous air, or 500 μ L of air in any consecutive 2 mL of fluid OFF: Air-in-line alarms at 1500 μ L or greater of continuous air	Press SECONDARY [VTBI] Each time SECONDARY [VTBI] is pressed, the setting will toggle.

Factory setting is L2 and is the level used for most applications with adult patients.

L1 may be indicated when used with increased need to monitor air-in-line.

OFF indicated when using Air Eliminating Filters such as used in Home Care for TPN etc. or when infusing enteral fluids/nourishment.

To activate all setting changes, press [ON/OFF] to power off the pump. Press [ON/OFF] again to power on the pump, and the new settings will be active.

6.0 TROUBLESHOOTING

This section contains solutions to correct routine clinical conditions that may occur while using the Acclaim *encore* Infusion Pump that do not require assistance from hospital or Hospira Technical Support Operations personnel.

Note: The Acclaim *encore* provides an optional Dose Calc function. This function is not enabled (off) when shipped from the factory. When not enabled, the [DOSE CALC] key does not respond to user input. To enable the Dose Calc function (per hospital protocol), contact your facilities Biomedical Department.

Problems that may occur in the Acclaim *encore* are in two categories: alarms and malfunctions.

6.1 Alarms

During an alarm condition, the screen backlight and the alarm message flash while an alarm sounds. To clear an alarm condition:

Disable lockout if in use.



Press the [SILENCE] key. Observe the alarm message that is flashing.



Correct the alarm condition as specified in the table below, then press [START]. **Verify flow in drip chamber.**

Note: If the alarm condition is not corrected, the alarm will occur again two minutes from when the [SILENCE] key was pressed.

This page intentionally left blank.

The following tips help correct the alarm conditions that may occur:

MESSAGE	POSSIBLE CAUSE	CORRECTIVE ACTION
AIR IN LINE	Air detected distal to pumping chamber See "Air Sensor" Note on page 18.	1) Purge (if enabled). Press and hold down on CLR key until air is visually past air sensor. Evaluate and remove air appropriately. OR 2) Press [STOP], remove and reprime set, then restart.
AIR IN LINE (CONT.)	Container empty	Change container and reprime set.
	Tubing not correctly loaded into sensor	Open/Close door or remove and reload tubing
CHECK DOOR	Tubing door open while pumping	Close door, then restart
CHECK SETTINGS	Primary rate or primary VTBI not set	Enter appropriate settings or press [CLR] key
	Taper VTBI or taper total time = 0	OR Press [ON/OFF] key twice to allow Clear Settings
	Taper steady state delivery rate is outside 1-999mL/hr	
	Taper total time is less than the sum of taper time up and taper time down	
	Emergency taper down is set to 0 during taper delivery	
	Computed Rate < 1 or >999 ML/HR	
	Dose Calculation, Drug Amount, Diluent, or Dose is 0.	

MESSAGE	POSSIBLE CAUSE	CORRECTIVE ACTION
	No green slide clamp installed with pump door closed	Open door and insert closed green slide clamp. Close door and resume programming.
CHECK 	Slide clamp has not fully closed upon detection of open door.	Press SILENCE or close door. If removing tubing, close roller clamp.
BATTERY	Approximately 30 minutes of battery power remains	Connect to AC power Note: Pressing the [SILENCE] key mutes the audible alarm for 15 minutes Note: When the battery discharges, pumping stops and the alarm sounds continuously for three minutes before the pump shuts down completely
BATTERY OFF	Battery is not capable of supporting battery operation.	Replace Battery Note: If interruption of Infusion (due to power) poses a patient hazard, remove pump from service. Note: Press [SILENCE] to clear BATTERY OFF message, turn the pump off, disconnect AC, correct problem, and reconnect AC.

MESSAGE	POSSIBLE CAUSE	CORRECTIVE ACTION
OCCLUSION	Clamp closed Tubing kinked Possible clotted catheter Possible misloaded tubing Proximal or distal occlusion	Open clamps Unkink tubing Check IV site Assure tubing properly loaded in the tube channel Check clamps, unlock tubing, or check IV site
STOPPED	No fluid delivery, no alarm conditions, and no key is pressed for five minutes	Restart or press [SILENCE] for an additional 5 minutes. Enter rate or VTBI settings, then press [START]. Verify flow in drip chamber
VTBI COMPLETE	Primary VTBI completed Taper VTBI completed Note: KVO also displays on the screen indicating the KVO rate is in progress	Discontinue infusion, or change container and program new VTBI setting
LOCKED	[STOP] key pressed during fluid delivery while keypad is locked	Unlock pump, program accordingly, press [START], reload pump. Verify flow in drip chamber.

6.2 Alerts

During interrupted programming of an infusion, an alert sounds every one minute if another key is not pressed. This will occur every minute up to five minutes. After five minutes, the STOPPED alarm will sound.

Note: This Alert will also occur when large digits are flashing to indicate incomplete titration. However, delivery will continue. Press [START] to clear this type of alert.

6.3 Malfunctions

Upon detection of a malfunction, an "Er" and an error number appear on the screen and the audible alarm sounds.

To verify the malfunction:

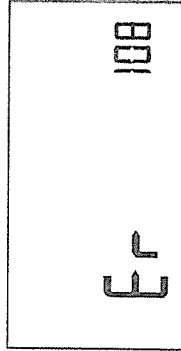

Turn the pump off, then on to retest the pump.

If the malfunction recurs, press the [SILENCE] key and note the malfunction number.

If the malfunction continues to recur, remove the Acclaim *encore* Infusion Pump from service.

If the lockout switch is in use, disable the lockout switch to enable turning the pump off.

6.4 Technical Assistance

For technical assistance, product return authorization, technical training information, or to order parts, accessories, or manuals, contact Hospira Technical Support Operations:

1-800-241-4002

Send all authorized, prepaid returns to the following address:

Hospira, Inc.
Technical Support Operations
755 Jarvis Drive
Morgan Hill, CA 95037

Do not return the Acclaim *encore* Infusion Pump without prior approval from Hospira Technical Support Operations.

For technical assistance from outside the U.S., contact the nearest Hospira representative.

MESSAGE	POSSIBLE CAUSE	CORRECTIVE ACTION
OCCLUSION	Clamp closed Tubing kinked Possible clotted catheter Possible misloaded tubing Proximal or distal occlusion	Open clamps Unkink tubing Check IV site Assure tubing properly loaded in the tube channel Check clamps, unlock tubing, or check IV site
STOPPED	No fluid delivery, no alarm conditions, and no key is pressed for five minutes	Restart or press [SILENCE] for an additional 5 minutes. Enter rate or VTBI settings, then press [START]. Verify flow in drip chamber
VTBI COMPLETE	Primary VTBI completed Taper VTBI completed Note: KVO also displays on the screen indicating the KVO rate is in progress	Discontinue infusion, or change container and program new VTBI setting
LOCKED	[STOP] key pressed during fluid delivery while keypad is locked	Unlock pump, program accordingly, press [START], relock pump. Verify flow in drip chamber.

6.2 Alerts

During interrupted programming of an infusion, an alert sounds every one minute if another key is not pressed. This will occur every minute up to five minutes. After five minutes, the STOPPED alarm will sound.

Note: This Alert will also occur when large digits are flashing to indicate incomplete titration. However, delivery will continue. Press [START] to clear this type of alert.

6.3 Malfunctions

Upon detection of a malfunction, an "Er" and an error number appear on the screen and the audible alarm sounds.

To verify the malfunction:

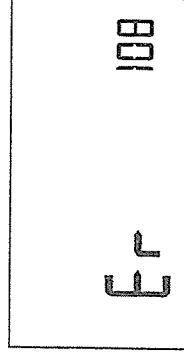

Turn the pump off, then on to retest the pump.

If the malfunction recurs, press the [SILENCE] key and note the malfunction number.

If the malfunction continues to recur, remove the Acclaim Encore Infusion Pump from service.

If the lockout switch is in use, disable the lockout switch to enable turning the pump off.

6.4 Technical Assistance

For technical assistance, product return authorization, technical training information, or to order parts, accessories, or manuals, contact Hospira Technical Support Operations:

1-800-241-4002

Send all authorized, prepaid returns to the following address:

Hospira, Inc.
Technical Support Operations
755 Jarvis Drive
Morgan Hill, CA 95037

Do not return the Acclaim Encore Infusion Pump without prior approval from Hospira Technical Support Operations.

For technical assistance from outside the U.S., contact the nearest Hospira representative.

7.0 PRECAUTIONS

For optimum operation of the Acclaim *encore* Infusion Pump, observe the following precautions.

7.1 Artifacts

Nonhazardous, low level electrical potentials are commonly observed when fluids are administered using infusion pumps. These potentials are well within accepted safety standards, but may create artifacts on voltage sensing equipment such as ECG, EMG, and EEG machines. These artifacts vary at a rate that is associated with the infusion rate. If the monitoring machine is not operating correctly or has loose or defective connections to its sensing electrodes, these artifacts may be accentuated so as to simulate actual physiological signals. To determine if the abnormality in the monitoring equipment is caused by the infusion pump instead of some other source in the environment, set the infusion pump so that it is temporarily not delivering fluid. Disappearance of the abnormality indicates that it was probably caused by the electronic noise generated by the infusion pump. Proper setup and maintenance of the monitoring equipment should eliminate the artifact. Refer to the appropriate monitoring equipment system documentation for setup and maintenance instructions.

This page intentionally left blank.

7.2 Healthcare Professional and Patient Related

Product checkout should be performed by qualified personnel only.

Arrange tubing, cords, and cables to minimize the risk of patient strangulation or entanglement.

Consult the drug container labeling to confirm drug compatibility, concentration, delivery rates, and volumes are all suitable for intermittent or continuous secondary or piggyback delivery mode.

Uncontrolled flow or no flow could occur if tubing not properly seated in the tubing channel.

Pull tubing straight, but do not stretch it during the loading process. Stretching tubing could result in underdelivery of fluids.

Always place filters distal to the infuser to minimize the possibility of underdelivery or an air-in-line alarm due to outgassing.

Before opening the tubing door, close the roller clamp on the primary set.

When starting an infusion, confirm that there is flow in the drip chamber after pressing the [START] key.

Setting the primary rate greater than the secondary rate will result in a more rapid infusion of any residual secondary drug remaining in the line.

When using the pump for piggyback delivery, confirm that the fluids being administered are chemically and physically compatible.

In vitro studies have suggested that packed red blood cells with unusually high hematocrit be diluted with blood-compatible fluids, such as 0.9% Sodium Chloride Injection, USP, to decrease hemolysis and increase flow rate.

To prevent freeflow, close the roller clamp on the primary set before removing the administration set from the pump.

Do not depress the green slide clamp slot tab while removing the tubing and slide clamp. Doing so could allow free flow to occur.

7.3 Epidural Administration

This device can be used to provide anesthesia or analgesia via the Epidural route for short-term infusion (up to 96 hours), with the following recommendations:

- Only anesthetic/analgesic agents approved for Epidural administration (as indicated or allowed by the drugs' FDA approved labeling)
- Nylon catheter (Hospira List No. 1193) or a Teflon® catheter (Hospira List No. 6947)
- Pump sets labeled for Epidural use without injection or Y-sites
- Labeling (pump and sets) to indicate on-going Epidural administration

Note: Facilities practicing epidural anesthesia/analgesia must be staffed and equipped to manage cardio-pulmonary resuscitation. Supplies should include oxygen, naloxone, and other appropriate resuscitative drugs and equipment. Continuous monitoring (e.g., oximetry) is recommended for the patient during epidural administration, as well as frequent patient observation for side effects (for up to 24 hours) following completion of drug administration by the epidural route. DELAYED RESPIRATORY DEPRESSION FOLLOWING CONTINUOUS EPIDURAL ADMINISTRATION OF PRESERVATIVE-FREE MORPHINE SULFATE HAS BEEN REPORTED.

7.4 Battery Operation

The battery may not be fully charged upon receipt. Connect the device to AC power for at least eight hours.

If the BATTERY alarm sounds, connect to AC power immediately, as the alarm indicates the battery is low.

7.5 Sets and Accessories

The Acclaim *encore* is compatible with a wide variety of Hospira administration sets.

WARNING

USE ONLY RECOMMENDED HOSPIRA GRAVITY SETS WITH GREEN SLIDE CLAMPS.

Note: Accessories are updated without notice. Contact a Hospira representative for current listings.

Guidelines for choosing recommended administration sets:

- When using administration sets with filters, only Hospira sets that include high pressure filters (i.e., can withstand up to 45 psig) should be used. The filter must be placed distal to the pump
- Standard 0.100 ID gravity sets with roller clamp distal to green slide clamp may be used with this pump
- Do not use:
 - Any sets without green slide clamps
 - Any burette sets with automatic shutoff valves or flapper valve sets
 - Any tubing that is .120 ID, .054 ID, .043 ID, or .033 ID
 - Any sets with flashback bulbs or latex sleeves on the distal end of the tubing

Special sets are available for the delivery of nitroglycerin, epidural infusion, 3-in-1 TPN, fats, enteral feedings, and blood.

Sets should be changed in accordance with current, recognized guidelines of IV therapy. Discard sets per hospital procedures.

IV infusion sets with integral nonblood filters are not for use in the administration of blood, blood products, emulsions, suspensions, or any medications not totally soluble in the solution being administered. These medications may be administered through the lower Y-injection site, below the filter.

7.6 General

Possible explosion hazard exists if used in the presence of flammable anesthetics.

Product damage may occur unless proper care is exercised during unpacking and checkout. Do not use the device if it appears damaged in any way.

Do not place the device in service if it fails the self-test (see Section 2.2, *Self-Test* for detailed information).

Use of radio frequency emitting devices such as cellular telephones, and two-way radios in close proximity of this pump may affect its operation.

This unit may be affected when used in close proximity to some Electrosurgical Units (ESU) when used at high power settings. Be sure to place the pump and administration sets away from the ESU device and its cables.

The screen displays total volume delivered in 0.1 mL increments from 1.0 to 99.9 mL. 100 to 9999 mL are displayed in 1-mL increments. Any fraction of a milliliter delivered is not displayed, but is retained in memory.

8.0 CLEANING, MAINTENANCE, AND STORAGE

This section describes the cleaning, maintenance, and storage of the Acclaim *encore* Infusion Pump.

8.1 Cleaning and Sanitizing

For proper maintenance of the pump, observe the following cleaning and sanitizing guidelines.

CAUTIONS: To avoid mechanical or electronic damage, do not immerse the pump in any cleaning fluids or cleaning solutions.

Certain cleaning and sanitizing compounds may slowly degrade components made from some plastic materials. Using abrasive cleaners or cleaning solutions not recommended by Hospira may result in product damage. Do not use compounds containing combinations of isopropyl alcohol and dimethyl benzyl ammonium chloride.

Never use sharp objects such as fingernails, paper clips, or needles to clean any part of the pump.

Do not sterilize by heat, steam, ethylene oxide (ETO), or radiation.

To avoid pump damage, cleaning solutions should be used only as directed in the following table. The disinfecting properties of cleaning solutions vary; consult the manufacturer for specific information.

This page intentionally left blank.

Establish a routine schedule for cleaning the Acclaim *encore*. To clean the pump:

ON/OFF

Turn the pump off, then disconnect the Acclaim *encore* from AC power.

The exposed surfaces of the Acclaim *encore* may be cleaned with a lint-free cloth dampened with one of the other recommended cleaning solutions listed as follows or mild, nonabrasive soapy water.

Cleaning Solution	Manufacturer	Preparation
Super Edisonite®	S. M. Edison Co.	Per manufacturer's recommendation
Vesphene® II se	Calgon Vestal Laboratories	Per manufacturer's recommendation
Manu-Klenz®	Calgon Vestal Laboratories	Per manufacturer's recommendation
Formula C™	Diversey Corporation	Per manufacturer's recommendation
Household bleach	Various	Per hospital procedures; do not exceed one part bleach in ten parts water
Coverage™ HBV	Steris Corporation, a division of Calgon Vestal Laboratories	Per manufacturer's recommendation
Sporicidin®	Sporicidin International	Per manufacturer's recommendation

8.2 Battery Maintenance

CAUTION: If the BATTERY alarm sounds, connect the Acclaim *encore* to AC power immediately.

The Acclaim *encore* can be battery powered for emergency backup and temporary portable operation. A fully

charged new battery will provide approximately eight hours of operation at 125 mL/hr or 1000 mL total volume delivered, whichever occurs first. The Acclaim *encore* should be operated on battery power for six continuous hours at least once every six months for optimum performance and battery life.

The battery charges whenever Acclaim *encore* is connected to AC power. If the Acclaim *encore* is turned off, recharge takes approximately eight hours. Recharge takes longer if the pump is turned on.

As a general rule, the more often the battery is partially discharged and recharged, the sooner it will need to be replaced. Consult a qualified hospital biomedical technician for battery replacement if necessary.

To maintain maximum battery charge and to prolong battery life, keep the AC power cord connected to AC power whenever possible.

8.3 Storage

To prolong the life of the Acclaim *encore*, observe the following guidelines:

- Turn the pump off
- Store the Acclaim *encore* away from excessive heat, cold, and humidity
- Store the Acclaim *encore* connected to AC power

8.4 Service

All servicing or adjustments to the Acclaim *encore* should be referred to qualified technical personnel. A Technical Service Manual may be ordered from Hospira Technical Support Operations.

9.0 SPECIFICATIONS

PHYSICAL:

Dimensions: Approximately 8.25H x 7W x 5.74D inches (excluding pole clamp)
Weight: Approximately 7 lbs (with battery)
Casing: High-impact plastic

ELECTRICAL:

Power Requirements: 100-130 VAC, 47/63 Hz, less than 35 W
Power Cord: 10 ft. Hospital-grade AC power cord

Fuses:

0.5 A, 250 V, Slow Blowing

Battery:

Sealed lead-acid, rechargeable 8 V battery, internal to device. Accessible for ease of field replacement, with leads and polarized connector

Battery Life:

A fully charged new battery will provide approximately eight hours of operation at 125 mL/hr or 1000 mL total volume delivered, whichever occurs first. The device should be operated on battery power for six continuous hours at least once every six months for optimum performance and battery life

Recharge:

The battery charges whenever the Acclaim *encore* is connected to AC power. If the pump is turned off, recharge takes approximately eight hours. Recharge takes longer if the pump is turned on.

ENVIRONMENT:

Operating Temperature:

15° to 35° C, 10% to 90% relative humidity

TRANSPORT AND STORAGE ENVIRONMENT:

Temperature:

-20° to 60° C

Relative Humidity:

10% to 90%

Atmospheric Pressure:

0-10,000 feet (0-3,000m) or equivalent pressure

This page intentionally left blank.

DELIVERY RATE RANGE:

Primary, Secondary Mode:
1.0 to 99.9 mL/hr (in 0.1 mL/hr increments)
100 to 999 mL/hr (in 1 mL/hr increments)

DOSE CALC RANGE:

Drug Amount: 0.1 - 9999 mg (0.1 increments below 100)
Diluent Volume: 0.1 - 3000 mL (0.1 increments below 100)
Patient Weight: 0, 1.0 -300 kg (0.1 kg increments)
Dose Rate: 0.1 -9999 µg/kg/min
(0.1 increments below 100, restricted by minimum delivery rate of 1.0 mL/hr and maximum rate of 999 mL/hr)

TPN RANGE:

Total Time: 0 to 24 hours

Taper Up: 0 to 180 minutes

Taper Down: 0 to 180 minutes

KVO: 1.0 mL/hr

VTBI RANGE:

1 to 9999 mL (in 1 mL increments)

DISTAL OCCLUSION RANGE:

Minimum: approximately 6 psi
Medium: approximately 10 psi
Maximum: approximately 20 psi

10.0 WARRANTY

Subject to the terms and conditions herein, Hospira, Inc., herein referred to as Hospira, warrants that (a) the product shall conform to Hospira's standard specifications and be free from defects in material and workmanship under normal use and service for a period of one year after purchase, and (b) the replaceable battery shall be free from defects in material and workmanship under normal use and service for a period of 90 days after purchase. Hospira makes no other warranties, express or implied, as to merchantability, fitness for a particular purpose, or any other matter.

Purchaser's exclusive remedy shall be, at Hospira's option, the repair or replacement of the product. In no event shall Hospira's liability arising out of any cause whatsoever (whether such cause be based in contract, negligence, strict liability, other tort or otherwise) exceed the price of such product, and in no event shall Hospira be liable for incidental, consequential, or special damages or losses or for lost business, revenues, or profits. Warranty product returned to Hospira must be properly packaged and sent freight prepaid.

The foregoing warranty shall be void in the event the product has been misused, damaged, altered, or used other than in accordance with product manuals so as, in Hospira's judgment, to affect its stability or reliability, or in the event the serial or lot number has been altered, effaced, or removed.

The foregoing warranty shall also be void in the event any person, including the Purchaser, performs or attempts to perform any major repair or other service on the product without having been trained by an authorized representative of Hospira and using Hospira documentation and approved spare parts. For purposes of the preceding sentence, "major repair or other service" means any repair or service other than the replacement of accessory items such as batteries and detachable AC power cords.

In providing any parts for repair or service of the product, Hospira shall have no responsibility or liability for the actions or inactions of the person performing such repair or service, regardless of whether such person has been trained to perform such repair or service. It is understood and acknowledged that any person other than a Hospira representative performing repair or service is not an authorized agent of Hospira.

For customer service within the United States, contact:

1-877-9HOSPIRA or 1-877-946-7747

For technical assistance and product return authorization within the United States, contact:

1-800-241-4002

For additional technical assistance, including Technical Service Bulletins, technical training, and product information, visit the website at:

www.hospira.com

After authorization, ship prepaid product returns to the following address:

Hospira, Inc.
Technical Support Operations
755 Jarvis Drive
Morgan Hill, CA 95037

Note: Outside the U.S., contact your local Hospira sales office.

CAUTION: Federal (USA) law restricts this pump to sale by or on the order of a physician or other licensed practitioner.

WARNING

POSSIBLE EXPLOSION HAZARD EXISTS IF THE PUMP IS USED IN THE PRESENCE OF FLAMMABLE ANESTHETICS.

Accelatin Infusion Pump and LifeShield are trademarks of Hospira, Inc. Teflon, Formula C, Mann-Kleinz, Vesphene II [®], Super Lidisonite, Coverage, and Sporidicin are not registered trademarks of Hospira, Inc.



NRTL/C
CSA 22.2/
No. 125
UL 544

CSA is a registered trademark of the Canadian Standards Association. The use of NRTL/C adjacent to the CSA mark indicates that the product has been certified by CSA to U.S. and Canadian Standards. CSA has been accredited by the U.S. Occupational Safety and Health Administration (OSHA), as a Nationally Recognized Test Laboratory (NRTL).

I.V. sets not included

MEDICAL EQUIPMENT

